

# NCP693

## 1A CMOS Low-Dropout Voltage Regulator

The NCP693 series of fixed output low dropout linear regulators are designed for portable battery powered applications with high output current requirement up to 1 A. Each device contains a voltage reference unit, an error amplifier, a PMOS power transistor, resistors for setting output voltage, a current limit circuits for over-current and thermal-shutdown. A standby mode with ultra low supply current can be realized with the chip enable function.

The device is housed in the DFN 1.8x2, 0.50P surface mount package. Standard voltage versions are 0.8 V, 1.0 V, 1.2 V, 2.5 V and 3.3 V.

### Features

- Maximum Operating Voltage of 6.5 V
- Low Output Voltage Option down to 0.8 V
- High Accuracy Output Voltage of 1.0%
- Built-in Auto Discharge Function for D Version
- These are Pb-Free Devices

### Typical Applications

- Battery Powered Instruments
- Hand-Held Instruments
- Camcorders and Cameras
- Portable communication equipments



**ON Semiconductor®**

<http://onsemi.com>

### MARKING DIAGRAM

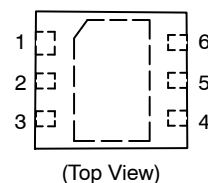
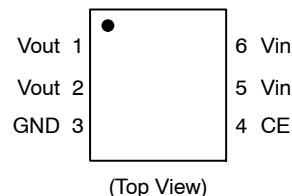


UDFN6, 1.8x2, 0.5P  
CASE 517BA



XXXX = Specific Device Code  
MM = Lot Number

### PIN DESCRIPTION



### ORDERING AND MARKING INFORMATION

See detailed ordering and shipping information in the package dimensions section on page 11 of this data sheet.

# NCP693

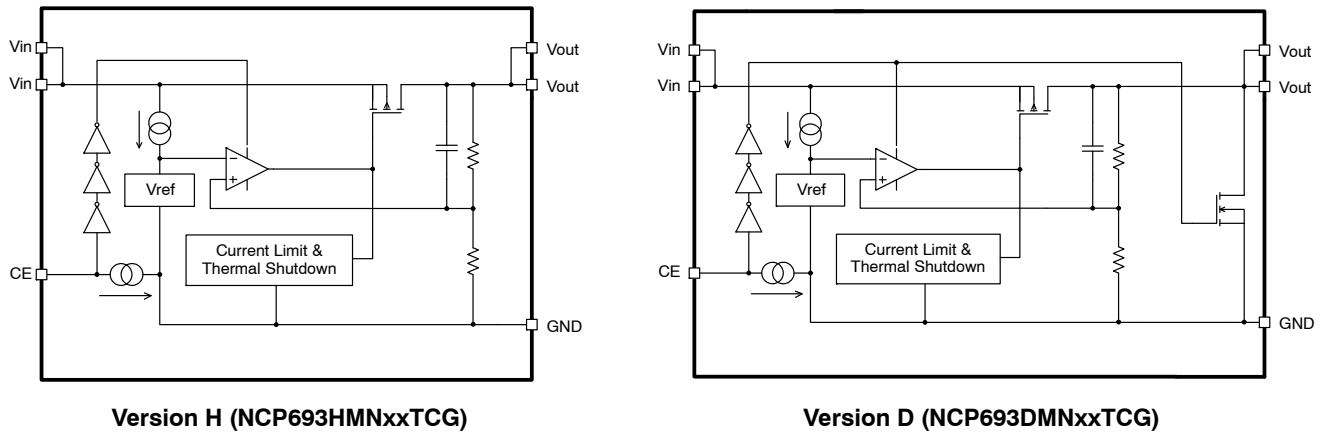


Figure 1. Internal Block Diagram

## PIN FUNCTION DESCRIPTION

Pin No.	Pin Name	Description
1	$V_{out}$	Regulated output voltage.
2	$V_{out}$	Regulated output voltage.
3	GND	Power supply ground.
4	CE	This input is used to place the device into low-power standby. When this input is pulled low, the device is disabled. If this function is not used, Enable should be connected to $V_{in}$ .
5	$V_{in}$	Positive power supply input voltage.
6	$V_{in}$	Positive power supply input voltage.
EP	GND	Power supply ground.

## MAXIMUM RATINGS

Rating	Symbol	Value	Unit
Input Voltage	$V_{in}$	7	V
Enable Voltage	$V_{CE}$	-0.3 to $V_{in}$	V
Output Voltage	$V_{out}$	-0.3 to $V_{in} + 0.3$	V
Operating Junction Temperature	$T_J$	+150	°C
Operating Ambient Temperature	$T_A$	-40 to +85	°C
Storage Temperature	$T_{stg}$	-55 to +125	°C

Stresses exceeding Maximum Ratings may damage the device. Maximum Ratings are stress ratings only. Functional operation above the Recommended Operating Conditions is not implied. Extended exposure to stresses above the Recommended Operating Conditions may affect device reliability.

- This device series contains ESD protection and exceeds the following tests:  
 Human Body Model 2000 V per (JEDEC 22-A114-B)  
 Machine Model Method 200 V

## THERMAL CHARACTERISTICS

Rating	Symbol	Test Conditions	Typical Value	Unit
Junction-to-Ambient	$R_{\theta JA}$	1 oz Copper Thickness, 100 mm <sup>2</sup>	114	°C/W
PSIJ-Lead 2	$\Psi_{J-L2}$	1 oz Copper Thickness, 100 mm <sup>2</sup>	25	°C/W
Power Dissipation	$P_D$		880	mW

NOTE: Single component mounted on an 80 x 80 x 1.5 mm FR4 PCB with stated copper head spreading area. Using the following boundary conditions as stated in EIA/JESD 51-1, 2, 3, 7, 12.

# NCP693

**ELECTRICAL CHARACTERISTICS** ( $V_{in} = V_{out(nom)} + 1.0\text{ V}$ ,  $V_{CE} = V_{in}$ ,  $C_{in} = 2.2\ \mu\text{F}$ ,  $C_{out} = 2.2\ \mu\text{F}$ ,  $T_A = 25^\circ\text{C}$ , unless otherwise noted)

Characteristic	Symbol	Min	Typ	Max	Unit
Output Voltage ( $T_A = 25^\circ\text{C}$ , $I_{out} = 10\text{ mA}$ ) 0.8 V 1.0 V 1.2 V 2.5 V 3.3 V	$V_{out}$	0.785 0.985 1.185 2.475 3.267	0.8 1.0 1.2 2.5 3.3	0.815 1.015 1.215 2.525 3.333	V
Output Voltage ( $T_A = -40^\circ\text{C}$ to $85^\circ\text{C}$ , $I_{out} = 10\text{ mA}$ ) 0.8 V 1.0 V 1.2 V 2.5 V 3.3 V	$V_{out}$	0.760 0.960 1.160 2.435 3.214	0.8 1.0 1.2 2.5 3.3	0.827 1.027 1.227 2.545 3.359	V
Output Current	$I_{out}$		1		A
Input Voltage	$V_{in}$	1.6		6.5	V
Line Regulation ( $V_{in} = V_{out} + 1.0\text{ V}$ to $6.5\text{ V}$ , $I_{out} = 10\text{ mA}$ )	$Reg_{line}$	–	0.05	0.1	%/V
Load Regulation ( $I_{out} = 1\text{ mA}$ to $300\text{ mA}$ , $V_{in} = V_{out} + 2.0\text{ V}$ )	$Reg_{load03}$	–	20	40	mV
Load Regulation ( $I_{out} = 1\text{ mA}$ to $1\text{ A}$ , $V_{in} = V_{out} + 2.0\text{ V}$ )	$Reg_{load1}$	–	80	120	mV
Supply Current ( $I_{out} = 0\text{ A}$ , $V_{in} = 6.5\text{ V}$ )	$I_{ss}$		65	90	$\mu\text{A}$
Standby Current ( $V_{CE} = 0\text{ V}$ , $V_{in} = 6.5\text{ V}$ )	$I_{stby}$		0.15	0.6	$\mu\text{A}$
Short Current Limit ( $V_{out} = 0\text{ V}$ )	$I_{sh}$		250		mA
Output Voltage Temperature Coefficient	$T_c$	–	$\pm 100$	–	ppm/ $^\circ\text{C}$
Enable Input Threshold Voltage (Voltage Increasing, Output Turns On, Logic High) (Voltage Decreasing, Output Turns Off, Logic Low)	$V_{thCE}$	1.0 –	– –	– 0.4	V
Enable Pulldown Current			0.3		$\mu\text{A}$
Drop Output Voltage ( $T_A = 25^\circ\text{C}$ , $I_{out} = 300\text{ mA}$ ) 0.8 V 1.0 V 1.2 V 2.5 V 3.3 V	$V_{in}-V_{out}$		0.670 0.450 0.300 0.150 0.130	0.780 0.610 0.500 0.310 0.170	V
Drop Output Voltage ( $T_A = 25^\circ\text{C}$ , $I_{out} = 1\text{ A}$ ) 0.8 V 1.0 V 1.2 V 2.5 V 3.3 V	$V_{in}-V_{out}$		1.150 1.000 0.870 0.500 0.430	1.650 1.450 1.380 1.100 0.650	V
Ripple Rejection (Ripple $200\text{ mV}_{pp}$ , $I_{out} = 100\text{ mA}$ , $f = 1\text{ kHz}$ )	PSRR		70		dB
Output Noise (BW = $10\text{ Hz}$ to $100\text{ kHz}$ , $I_{out} = 1\text{ mA}$ )	$V_{noise}$		45		$\mu\text{V}_{rms}$
Thermal Shutdown Temperature/Hysteresis	$T_{shd}/Hyst$		165/30		$^\circ\text{C}$
$R_{DS(on)}$ of additional output transistor (D version only)	$R_{DS(on)}$		30		$\Omega$

2. Maximum package power dissipation limits must be observed.
3. Low duty cycle pulse techniques are used during testing to maintain the junction temperature as close to ambient as possible.

# NCP693

## APPLICATIONS INFORMATION

A typical application circuit for the NCP693 series is shown in Figure 2.

### Input Decoupling (C1)

A 2.2  $\mu\text{F}$  capacitor either ceramic or tantalum is recommended and should be connected as close as possible to the pins of NCP693 device. Higher values and lower ESR will improve the overall line transient response.

### Output Decoupling (C2)

The minimum decoupling value is 2.2  $\mu\text{F}$  and can be augmented to fulfill stringent load transient requirements. The regulator accepts ceramic chip capacitors as well as tantalum devices. If a tantalum capacitor is used, and its ESR is large, the loop oscillation may result. Because of this, select C2 carefully considering its frequency characteristics. Larger values improve noise rejection and load regulation transient response.

### Enable Operation

The enable pin CE will turn on or off the regulator. These limits of threshold are covered in the electrical specification section of this data sheet. If the enable is not used then the pin should be connected to  $V_{\text{in}}$ . The D version devices

(NCP693DMNxxTCG) have additional circuitry in order to reach the turn-off speed faster than normal type. When the mode is into standby with CE signal, auto discharge transistor turns on.

### Hints

Please be sure the  $V_{\text{in}}$  and GND lines are sufficiently wide. If their impedance is high, noise pickup or unstable operation may result.

Set external components, especially the output capacitor, as close as possible to the circuit, and make leads as short as possible.

### Thermal

As power across the NCP693 increases, it might become necessary to provide some thermal relief. The maximum power dissipation supported by the device is dependent upon board design and layout. Mounting pad configuration on the PCB, the board material, and also the ambient temperature effect the rate of temperature rise for the part. This is stating that when the NCP693 has good thermal conductivity through the PCB, the junction temperature will be relatively low with high power dissipation applications.

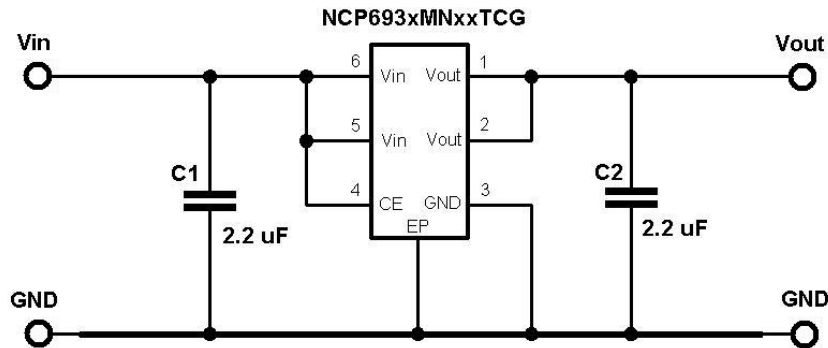
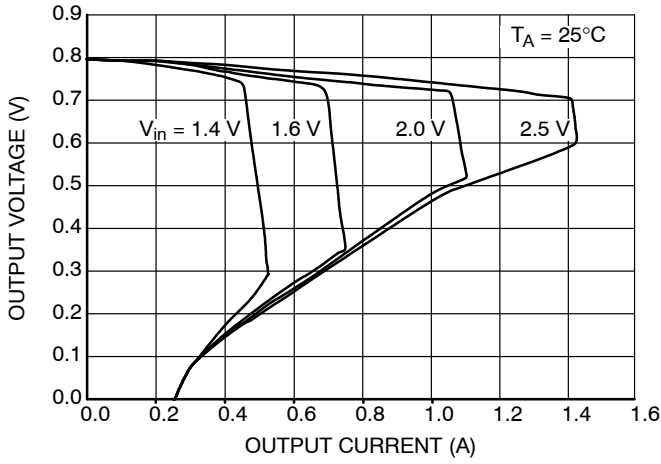
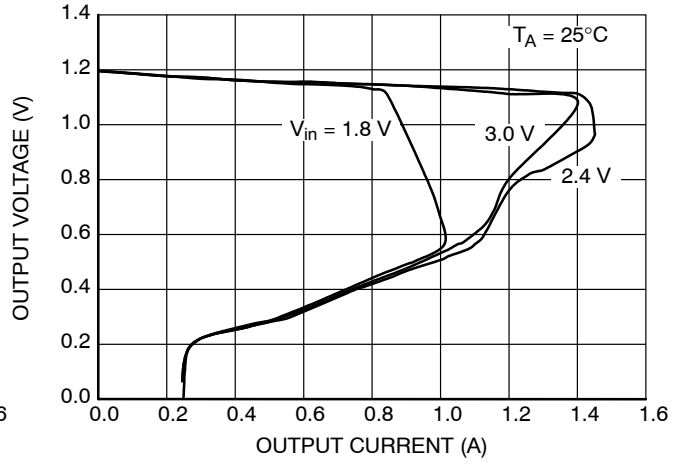


Figure 2. Typical Application Circuit

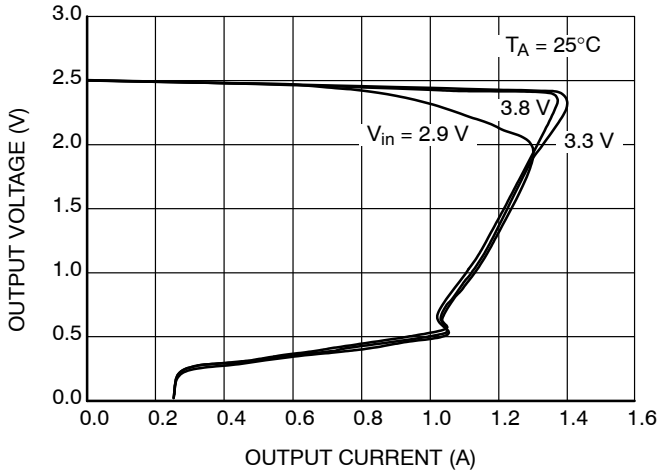
# NCP693



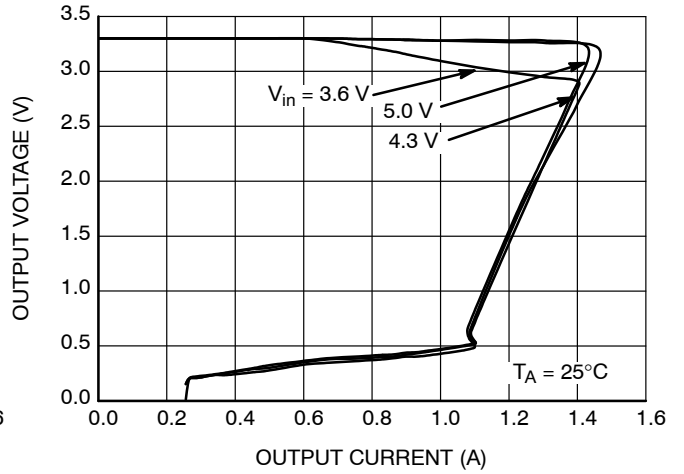
**Figure 3. Output Voltage vs. Output Current  
NCP693xMN08TCG**



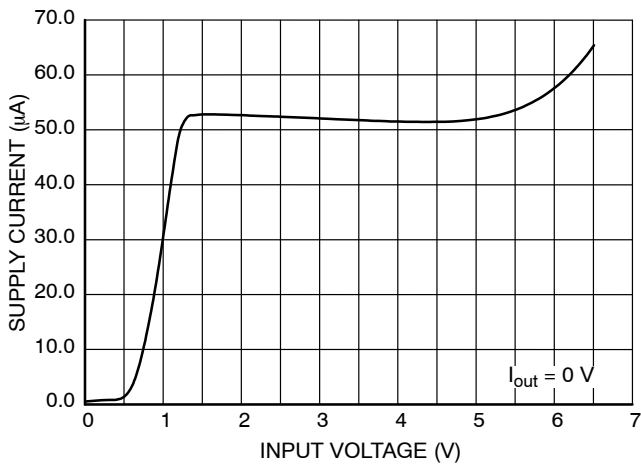
**Figure 4. Output Voltage vs. Output Current  
NCP693xMN12TCG**



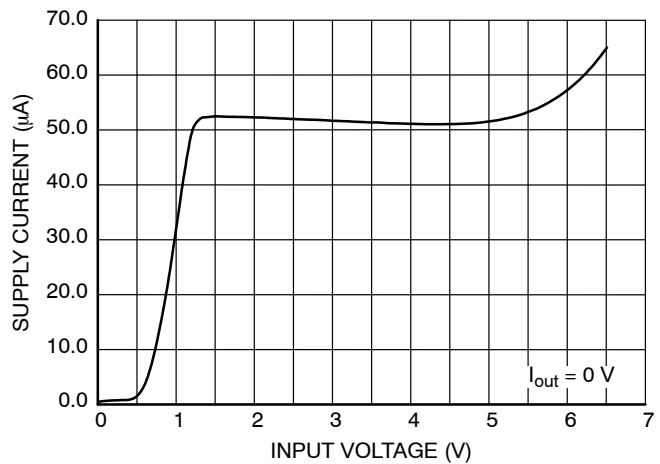
**Figure 5. Output Voltage vs. Output Current  
NCP693xMN25TCG**



**Figure 6. Output Voltage vs. Output Current  
NCP693xMN33TCG**

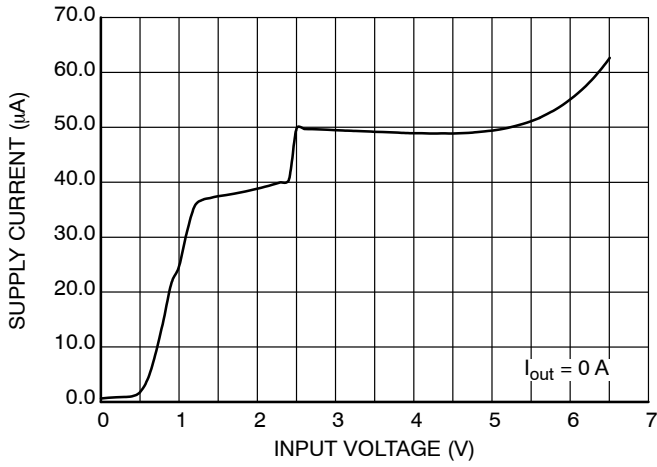


**Figure 7. Supply Current vs. Input Voltage  
NCP693xMN08TCG**

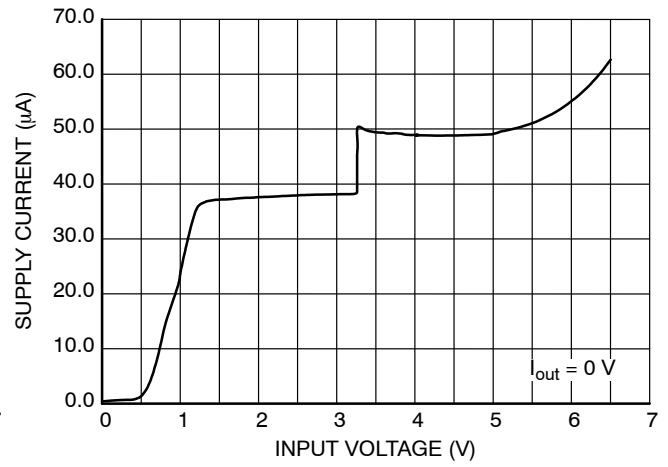


**Figure 8. Supply Current vs. Input Voltage  
NCP693xMN12TCG**

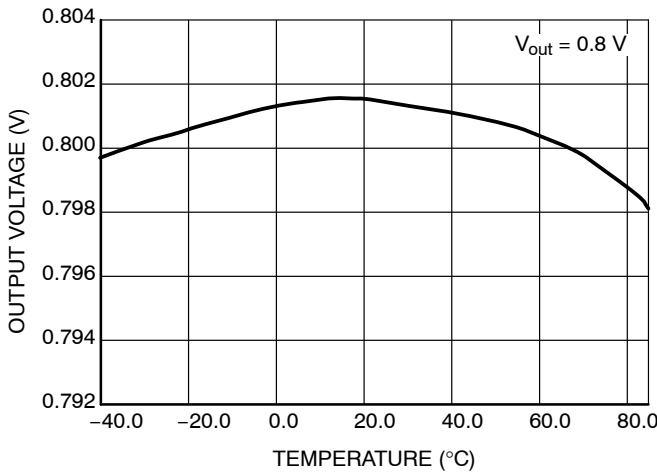
# NCP693



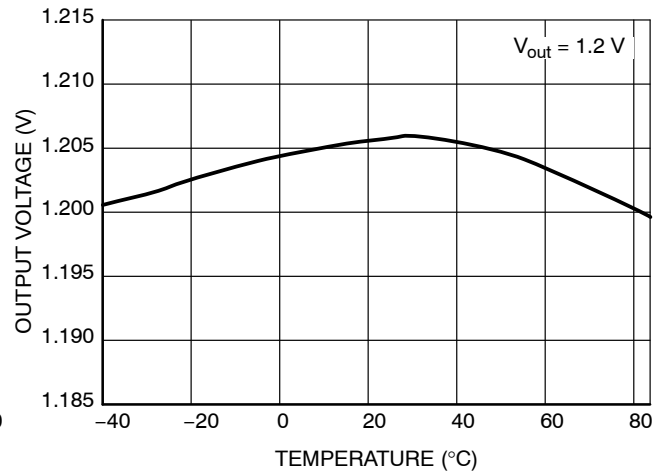
**Figure 9. Supply Current vs. Input Voltage  
NCP693xMN25TCG**



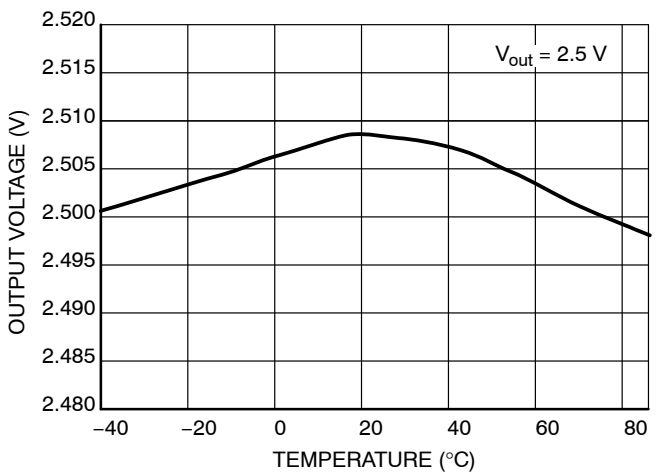
**Figure 10. Supply Current vs. Input Voltage  
NCP693xMN33TCG**



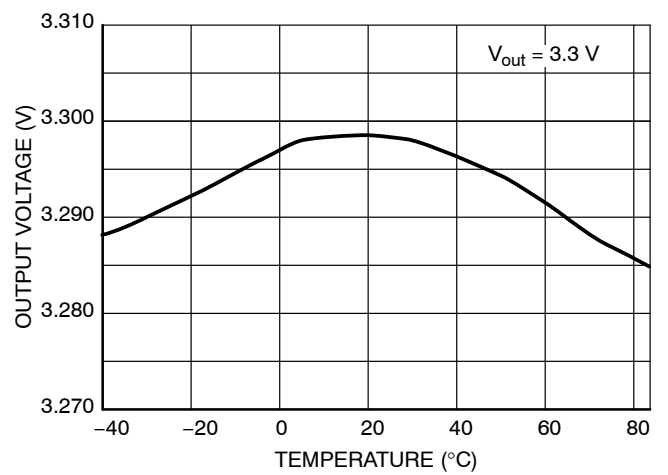
**Figure 11. Output Voltage vs. Temperature  
NCP693xMN08TCG**



**Figure 12. Output Voltage vs. Temperature  
NCP693xMN12TCG**

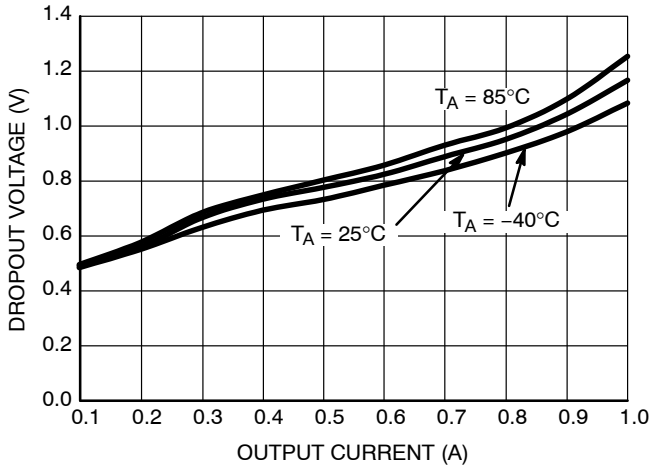


**Figure 13. Output Voltage vs. Temperature  
NCP693xMN25TCG**

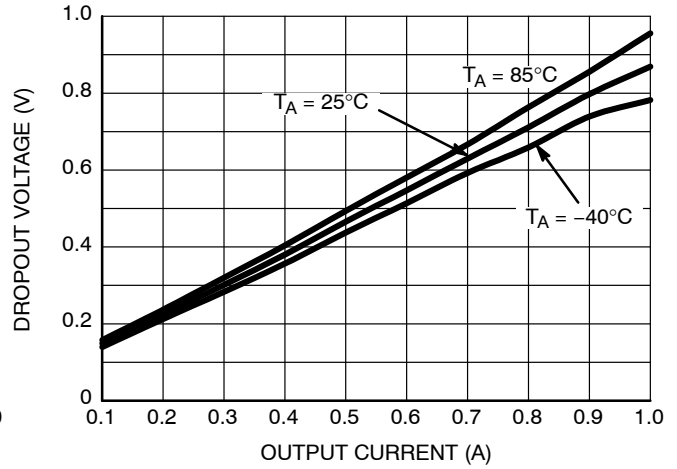


**Figure 14. Output Voltage vs. Temperature  
NCP693xMN33TCG**

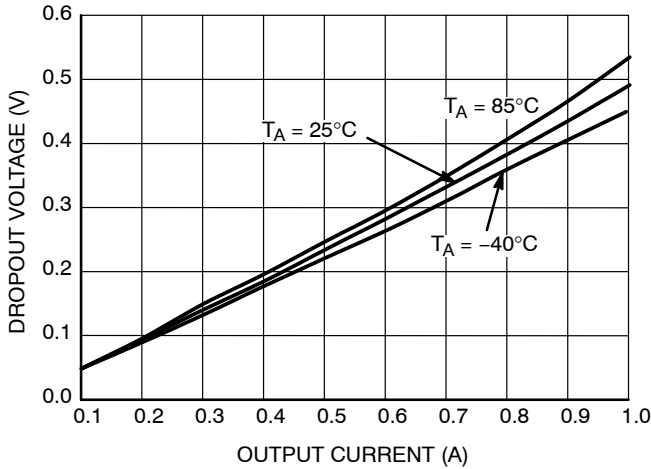
# NCP693



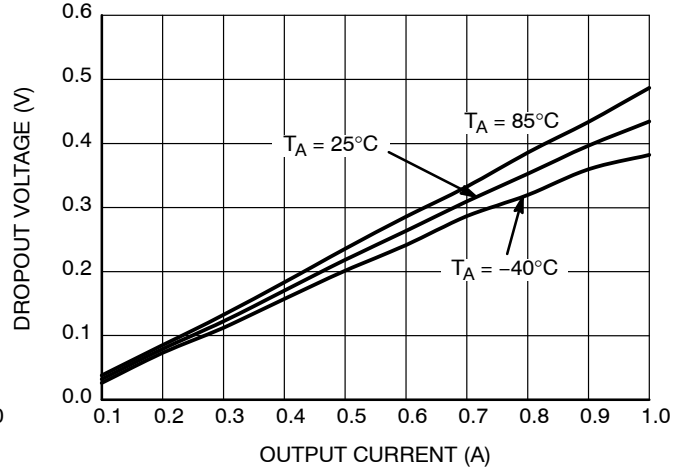
**Figure 15. Dropout Voltage vs. Output Current  
NCP693xMN08TCG**



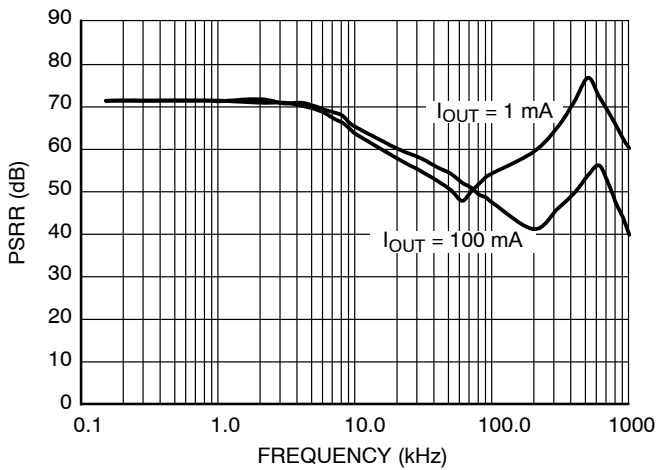
**Figure 16. Dropout Voltage vs. Output Current  
NCP693xMN12TCG**



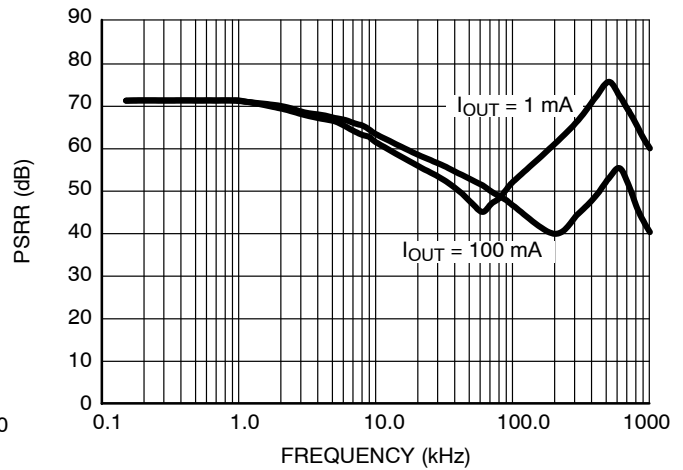
**Figure 17. Dropout Voltage vs. Output Current  
NCP693xMN25TCG**



**Figure 18. Dropout Voltage vs. Output Current  
NCP693xMN33TCG**

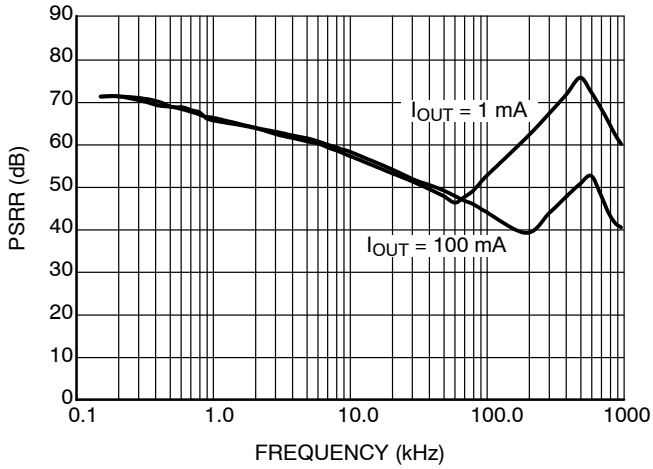


**Figure 19. PSRR vs. Frequency  
NCP693xMN08TCG**

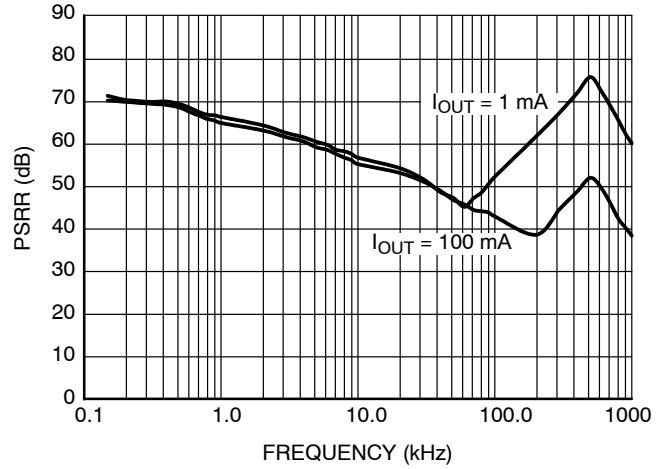


**Figure 20. PSRR vs. Frequency  
NCP693xMN12TCG**

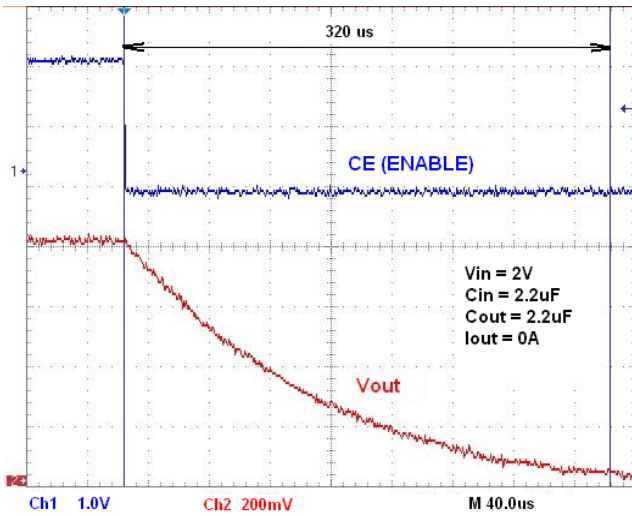
# NCP693



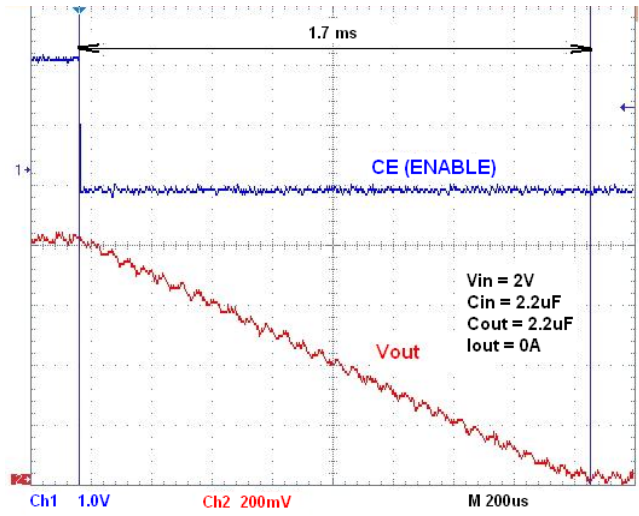
**Figure 21. PSRR vs. Frequency  
NCP693xMN25TCG**



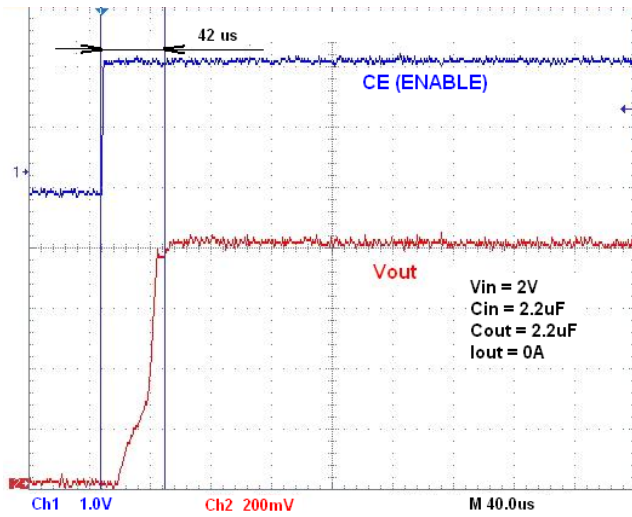
**Figure 22. PSRR vs. Frequency  
NCP693xMN33TCG**



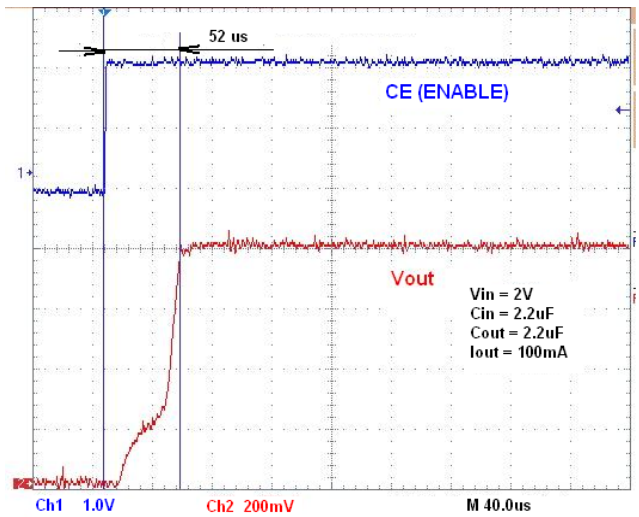
**Figure 23. Turn Off Speed NCP693DMN08TCG**



**Figure 24. Turn Off Speed NCP693HMN08TCG**



**Figure 25. Turn On Speed NCP693xMN08CTG**



**Figure 26. Turn On Speed NCP693xMN08CTG**



# NCP693

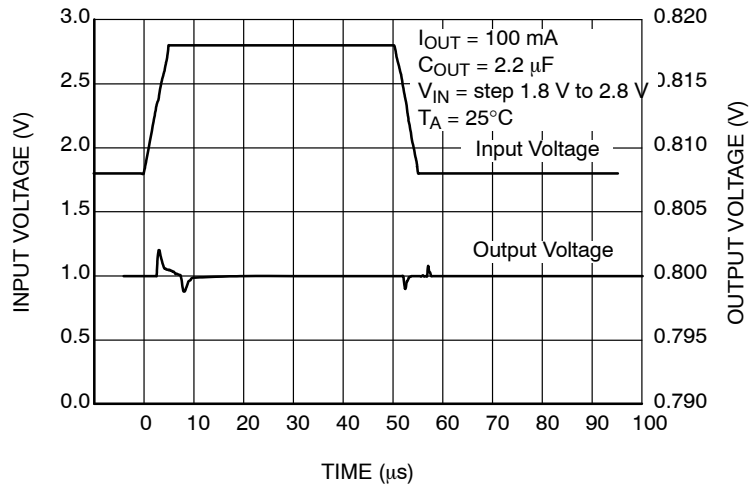


Figure 27. Input Response NCP693xMN08TCG

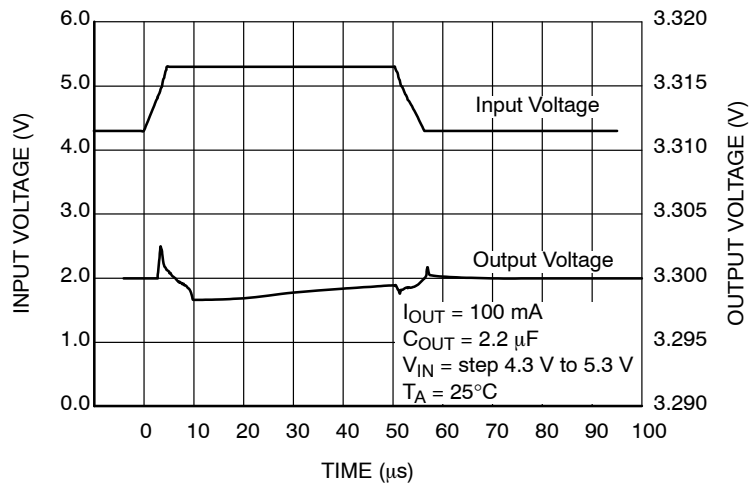


Figure 28. Input Response NCP693xMN33TCG

# NCP693

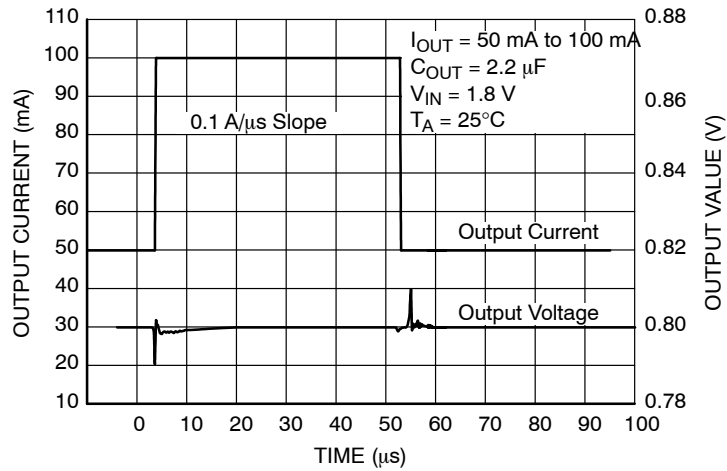


Figure 29. Input Response NCP693xMN08TCG

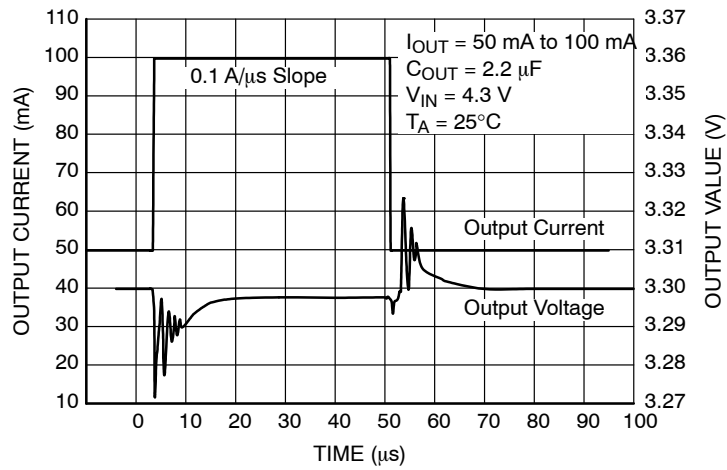


Figure 30. Input Response NCP693xMN33TCG

# NCP693

## ORDERING INFORMATION

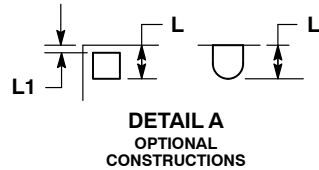
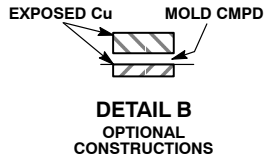
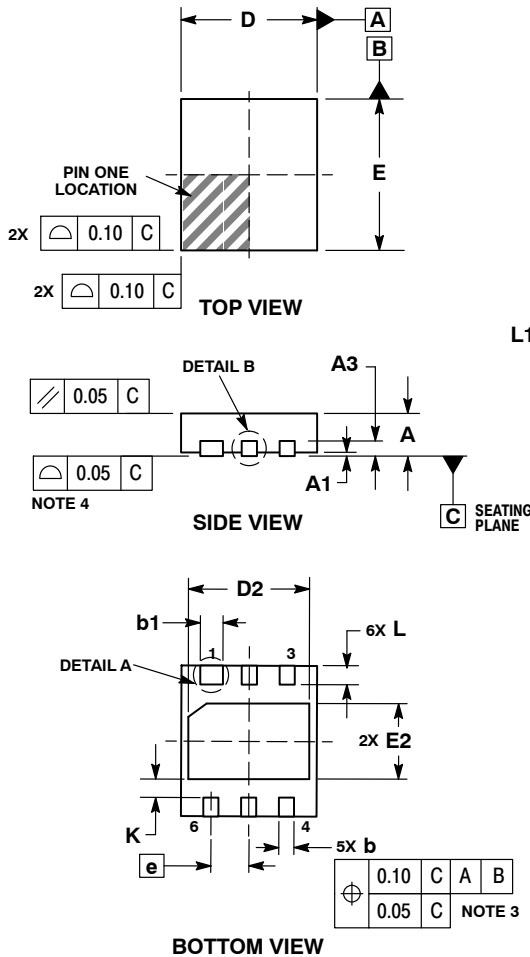
Device	Nominal Output Voltage	Marking	Package	Shipping <sup>†</sup>
NCP693HMN08TCG	0.8	AM01	DFN (Pb-Free)	5000 / Tape & Reel
NCP693HMN10TCG	1.0	AM03	DFN (Pb-Free)	5000 / Tape & Reel
NCP693HMN12TCG	1.2	AM06	DFN (Pb-Free)	5000 / Tape & Reel
NCP693HMN25TCG	2.5	AM20	DFN (Pb-Free)	5000 / Tape & Reel
NCP693HMN33TCG	3.3	AM29	DFN (Pb-Free)	5000 / Tape & Reel
NCP693DMN08TCG	0.8	AN01	DFN (Pb-Free)	5000 / Tape & Reel
NCP693DMN10TCG	1.0	AN03	DFN (Pb-Free)	5000 / Tape & Reel
NCP693DMN12TCG	1.2	AN06	DFN (Pb-Free)	5000 / Tape & Reel
NCP693DMN25TCG	2.5	AN20	DFN (Pb-Free)	5000 / Tape & Reel
NCP693DMN33TCG	3.3	AN29	DFN (Pb-Free)	5000 / Tape & Reel

<sup>†</sup>For information on tape and reel specifications, including part orientation and tape sizes, please refer to our Tape and Reel Packaging Specifications Brochure, BRD8011/D.

# NCP693

## PACKAGE DIMENSIONS

UDFN6, 1.8x2, 0.5P  
CASE 517BA-01  
ISSUE A

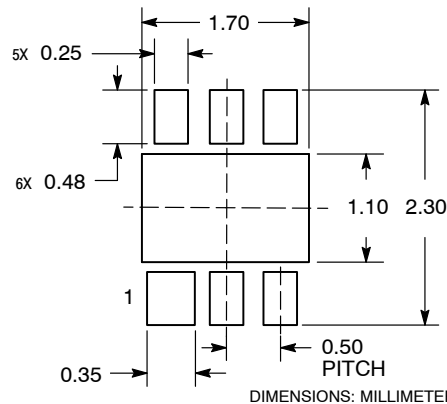


**NOTES:**

1. DIMENSIONING AND TOLERANCING PER ASME Y14.5M, 1994.
2. CONTROLLING DIMENSION: MILLIMETERS.
3. DIMENSION b APPLIES TO PLATED TERMINAL AND IS MEASURED BETWEEN 0.15 AND 0.20mm FROM THE TERMINAL TIP.
4. COPLANARITY APPLIES TO THE EXPOSED PAD AS WELL AS THE TERMINALS.

DIM	MILLIMETERS	
	MIN	MAX
A	0.50	0.60
A1	0.00	0.05
A3	0.20 REF	
b	0.15	0.30
b1	0.20	0.40
D	1.80 BSC	
D2	1.50	1.70
E	2.00 BSC	
E2	0.90	1.10
e	0.50 BSC	
K	0.20	---
L	0.15	0.35
L1	---	0.10

**RECOMMENDED MOUNTING FOOTPRINT\***



\*For additional information on our Pb-Free strategy and soldering details, please download the ON Semiconductor Soldering and Mounting Techniques Reference Manual, SOLDERRM/D.

ON Semiconductor and are registered trademarks of Semiconductor Components Industries, LLC (SCILLC). SCILLC reserves the right to make changes without further notice to any products herein. SCILLC makes no warranty, representation or guarantee regarding the suitability of its products for any particular purpose, nor does SCILLC assume any liability arising out of the application or use of any product or circuit, and specifically disclaims any and all liability, including without limitation special, consequential or incidental damages. "Typical" parameters which may be provided in SCILLC data sheets and/or specifications can and do vary in different applications and actual performance may vary over time. All operating parameters, including "Typicals" must be validated for each customer application by customer's technical experts. SCILLC does not convey any license under its patent rights nor the rights of others. SCILLC products are not designed, intended, or authorized for use as components in systems intended for surgical implant into the body, or other applications intended to support or sustain life, or for any other application in which the failure of the SCILLC product could create a situation where personal injury or death may occur. Should Buyer purchase or use SCILLC products for any such unintended or unauthorized application, Buyer shall indemnify and hold SCILLC and its officers, employees, subsidiaries, affiliates, and distributors harmless against all claims, costs, damages, and expenses, and reasonable attorney fees arising out of, directly or indirectly, any claim of personal injury or death associated with such unintended or unauthorized use, even if such claim alleges that SCILLC was negligent regarding the design or manufacture of the part. SCILLC is an Equal Opportunity/Affirmative Action Employer. This literature is subject to all applicable copyright laws and is not for resale in any manner.

**PUBLICATION ORDERING INFORMATION**

**LITERATURE FULFILLMENT:**  
Literature Distribution Center for ON Semiconductor  
P.O. Box 5163, Denver, Colorado 80217 USA  
**Phone:** 303-675-2175 or 800-344-3860 Toll Free USA/Canada  
**Fax:** 303-675-2176 or 800-344-3867 Toll Free USA/Canada  
**Email:** orderlit@onsemi.com

**N. American Technical Support:** 800-282-9855 Toll Free USA/Canada  
**Europe, Middle East and Africa Technical Support:**  
Phone: 421 33 790 2910  
**Japan Customer Focus Center**  
Phone: 81-3-5773-3850

**ON Semiconductor Website:** [www.onsemi.com](http://www.onsemi.com)  
**Order Literature:** <http://www.onsemi.com/orderlit>  
For additional information, please contact your local Sales Representative