

2SB1589

Silicon PNP epitaxial planar type

For low-frequency output amplification

■ Features

- Low collector-emitter saturation voltage $V_{CE(sat)}$
- Large collector power dissipation P_C
- Mini Power type package, allowing downsizing of the equipment and automatic insertion through the tape packing and the magazine packing.

■ Absolute Maximum Ratings $T_a = 25^\circ\text{C}$

Parameter	Symbol	Rating	Unit
Collector-base voltage (Emitter open)	V_{CBO}	-10	V
Collector-emitter voltage (Base open)	V_{CEO}	-10	V
Emitter-base voltage (Collector open)	V_{EBO}	-7	V
Collector current	I_C	-1.5	A
Peak collector current	I_{CP}	-2	A
Collector power dissipation *	P_C	1	W
Junction temperature	T_j	150	$^\circ\text{C}$
Storage temperature	T_{stg}	-55 to +150	$^\circ\text{C}$

Note) *: Print circuit board: Copper foil area of 1 cm² or more, and the board thickness of 1.7 mm for the collector portion

■ Electrical Characteristics $T_a = 25^\circ\text{C} \pm 3^\circ\text{C}$

Parameter	Symbol	Conditions	Min	Typ	Max	Unit
Collector-base voltage (Emitter open)	V_{CBO}	$I_C = -10 \mu\text{A}$, $I_E = 0$	-10			V
Collector-emitter voltage (Base open)	V_{CEO}	$I_C = -1 \text{ mA}$, $I_B = 0$	-10			V
Emitter-base voltage (Collector open)	V_{EBO}	$I_E = -10 \mu\text{A}$, $I_C = 0$	-7			V
Collector-base cutoff current (Emitter open)	I_{CBO}	$V_{CB} = -7 \text{ V}$, $I_E = 0$			-1	μA
Forward current transfer ratio *1	h_{FE}	$V_{CE} = -1 \text{ V}$, $I_C = -400 \text{ mA}$	200		700	—
Collector-emitter saturation voltage *1	$V_{CE(sat)}$	$I_C = -1 \text{ A}$, $I_B = -25 \text{ mA}$		-0.24	-0.35	V
Transition frequency	f_T	$V_{CB} = -6 \text{ V}$, $I_E = 50 \text{ mA}$, $f = 200 \text{ MHz}$		190		MHz
Collector output capacitance (Common base, input open circuited)	C_{ob}	$V_{CB} = -10 \text{ V}$, $I_E = 0$, $f = 1 \text{ MHz}$		65		pF
Forward voltage *2	V_F	$I_F = -500 \text{ mA}$			-1.3	V

Note) 1. Measuring methods are based on JAPANESE INDUSTRIAL STANDARD JIS C 7030 measuring methods for transistors.

2. *1: Pulse measurement

*2: Applicable to the built-in diode

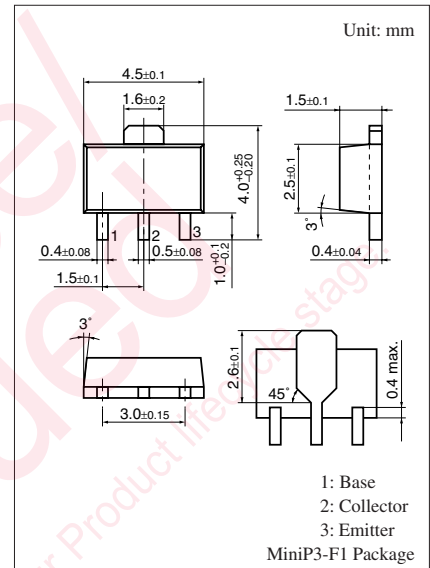

Marking Symbol: 1U

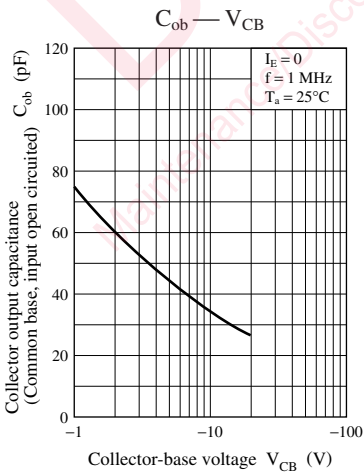
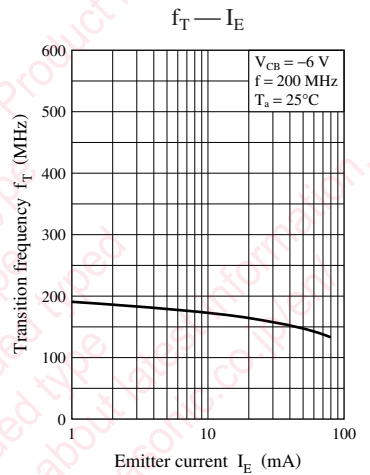
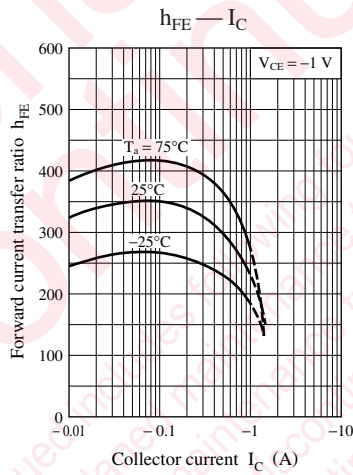
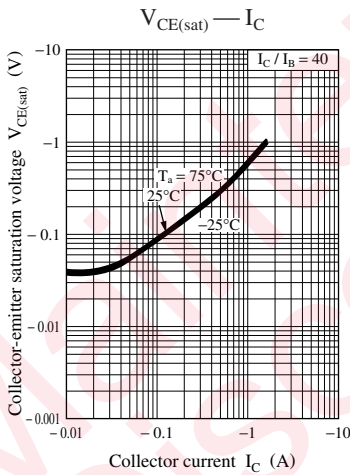
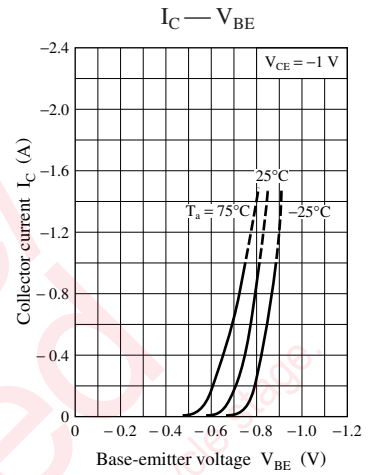
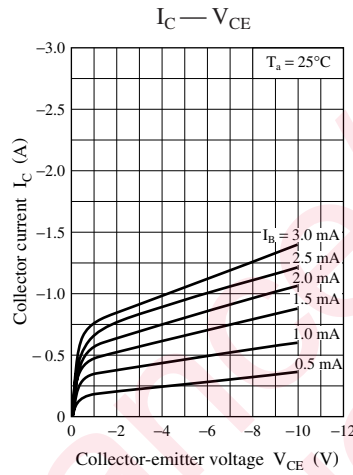
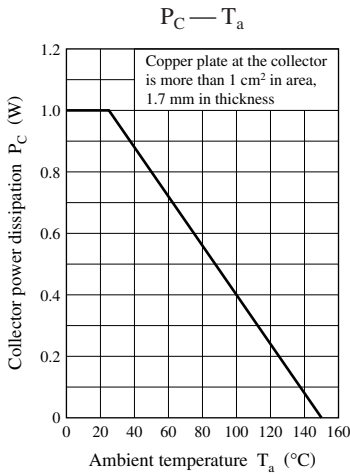

Request for your special attention and precautions in using the technical information and semiconductors described in this book

- (1) If any of the products or technical information described in this book is to be exported or provided to non-residents, the laws and regulations of the exporting country, especially, those with regard to security export control, must be observed.
- (2) The technical information described in this book is intended only to show the main characteristics and application circuit examples of the products, and no license is granted under any intellectual property right or other right owned by our company or any other company. Therefore, no responsibility is assumed by our company as to the infringement upon any such right owned by any other company which may arise as a result of the use of technical information described in this book.
- (3) The products described in this book are intended to be used for standard applications or general electronic equipment (such as office equipment, communications equipment, measuring instruments and household appliances).
Consult our sales staff in advance for information on the following applications:
 - Special applications (such as for airplanes, aerospace, automobiles, traffic control equipment, combustion equipment, life support systems and safety devices) in which exceptional quality and reliability are required, or if the failure or malfunction of the products may directly jeopardize life or harm the human body.
 - Any applications other than the standard applications intended.
- (4) The products and product specifications described in this book are subject to change without notice for modification and/or improvement. At the final stage of your design, purchasing, or use of the products, therefore, ask for the most up-to-date Product Standards in advance to make sure that the latest specifications satisfy your requirements.
- (5) When designing your equipment, comply with the range of absolute maximum rating and the guaranteed operating conditions (operating power supply voltage and operating environment etc.). Especially, please be careful not to exceed the range of absolute maximum rating on the transient state, such as power-on, power-off and mode-switching. Otherwise, we will not be liable for any defect which may arise later in your equipment.
 - Even when the products are used within the guaranteed values, take into the consideration of incidence of break down and failure mode, possible to occur to semiconductor products. Measures on the systems such as redundant design, arresting the spread of fire or preventing glitch are recommended in order to prevent physical injury, fire, social damages, for example, by using the products.
- (6) Comply with the instructions for use in order to prevent breakdown and characteristics change due to external factors (ESD, EOS, thermal stress and mechanical stress) at the time of handling, mounting or at customer's process. When using products for which damp-proof packing is required, satisfy the conditions, such as shelf life and the elapsed time since first opening the packages.
- (7) This book may be not reprinted or reproduced whether wholly or partially, without the prior written permission of Matsushita Electric Industrial Co., Ltd.