

# F11

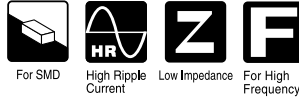

- Higher Capacitance.
- Low ESR, Low ESL, High ripple current.
- Resin-molded Chip.
- Designed for surface mounting on high density PC board.
- Load life of 5000 hours at +105°C.
- Compliant to the RoHS directive (2002/95/EC).

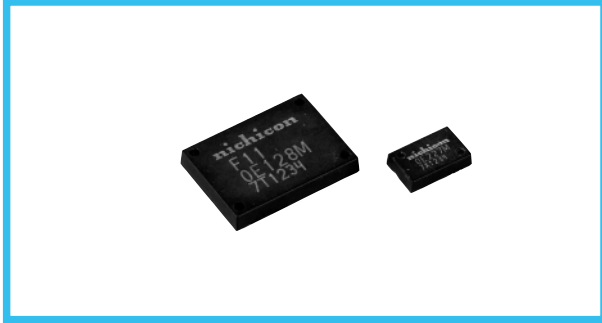

### Type numbering system (Example : 2.5V 220μF)

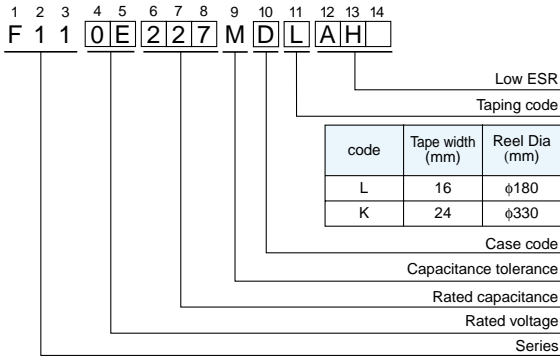

### Dimensions

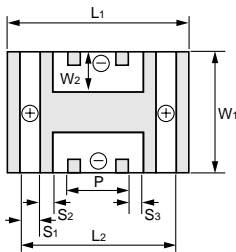

Case Code	L <sub>1</sub>	L <sub>2</sub>	W <sub>1</sub>	W <sub>2</sub>	H	S <sub>1</sub>	S <sub>2</sub>	S <sub>3</sub>	P
D	8.5 ± 0.2	7.3 ± 0.2	5.3 ± 0.2	1.7 ± 0.2	2.0MAX.	0.9 ± 0.2	0.6 ± 0.2	0.5 ± 0.2	3.3 ± 0.2
F	16.7 ± 0.2	15.6 ± 0.2	12.1 ± 0.2	3.6 ± 0.2	2.5MAX.	1.5 ± 0.1	1.3 ± 0.1	1.5 ± 0.2	7.0 ± 0.2

### Marking

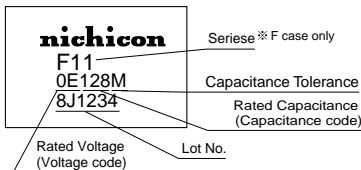

### Specifications

Item	Performance Characteristics		
Category Temperature Range	-55 to +105°C		
Capacitance Tolerance	±20% (at 120Hz)		
Dissipation Factor	Refer to next table		
ESR	Refer to next table		
Leakage Current	After 5 minute's application of rated voltage, leakage current is not more than 0.1CV		
Damp Heat (Steady State)	At 60°C 90%RH 500hours (No voltage applied)		
	Capacitance Change·····Within -20 to +30% of the initial specified value		
	Dissipation Factor·····200% or less than the Initial specified value		
	ESR·····200% or less than the Initial specified value		
Temperature Cycles	-55°C / +105°C 30minutes each 5cycle		
	Capacitance Change·····Within ±20% of the Initial specified value		
	Dissipation Factor·····200% or less than the Initial specified value		
	ESR·····200% or less than the Initial specified value		
Temperature Change Characteristics	-55°C	+105°C	
	Capacitance Change	Within -20 to +0%	Within -0 to +50%
	Dissipation Factor	Initial specified value or less	150% or less than the Initial specified value
	ESR	Initial specified value or less	150% or less than the Initial specified value
Resistance to Soldering Heat	Capacitor meets the following characteristics after solder reflow (Peak: 240°C for 10sec, 2cycle). Temperature should be measured at the terminals.		
	Capacitance Change·····	Within ±20% of the Initial specified value	
	Dissipation Factor·····	Initial specified value or less	
	ESR·····	Initial specified value or less	
Surge	After application of 115% of rating voltage at the rate of 30 seconds ON, 30 seconds OFF, for 1000 successive test cycles at 105°C, capacitors meet the characteristics requirements listed below.		
	Capacitance Change·····	Within ±20% of the initial specified value	
	Dissipation Factor·····	200% or less than the Initial specified value	
	ESR·····	200% or less than the Initial specified value	
Endurance	After 5000 hours' application of rated voltage at 105°C, they will meet the specified value for life characteristics listed below.		
	Capacitance Change·····	Within ±20% of the initial value	
	Dissipation Factor·····	200% or less than the Initial specified value	
	ESR·····	200% or less than the Initial specified value	
Marking	Printed on the package top.		

### Standard ratings

Cap.(μF)	Code	V		
		2.5	4	6.3
47	476	0E	0G	0J
100	107	D	D	(D)
220	227	D	(D)	
330	337	(D)		
600	607	F		F
800	807		F	
1200	128	F		

( ) The series in parentheses are being developed. Please contact to your local Nichicon sales office when these series are being designed in your application.

## F11

### ■ Ratings Table

#### < Standard >

Rated Volt (V)	Rated Capacitance (μF)	Case code	Part Number	Leakage Current (μA)	Dissipation Factor (% @ 120Hz)	ESR (mΩ @ 100kHz)	Rated Ripple (Arms @ 100kHz)
2.5	100	D	F110E107MDL	25	5	20.0	3.5
	220	D	F110E227MDL	55	5	20.0	3.5
	600	F	F110E607MFK	150	10	5.0	6.3
	1200	F	F110E128MFK	300	10	5.0	6.3
4	47	D	F110G476MDL	19	5	20.0	3.5
	100	D	F110G107MDL	40	5	20.0	3.5
	800	F	F110G807MFK	320	10	5.0	6.3
6.3	47	D	F110J476MDL	30	5	20.0	3.5
	600	F	F110J607MFK	378	10	5.0	6.3

#### < Low ESR >

Rated Volt (V)	Rated Capacitance (μF)	Case code	Part Number	Leakage Current (μA)	Dissipation Factor (% @ 120Hz)	ESR (mΩ @ 300kHz)	Rated Ripple (Arms @ 300kHz)
2.5	220	D	F110E227MDLAH1	55	5	12.0	4.5
	1200	F	F110E128MFKAH3	300	10	1.5	11.5
4	100	D	F110G107MDLAH1	40	5	15.0	4.0
6.3	47	D	F110J476MDLAH1	30	5	15.0	4.0

### ■ Layout Land Pattern (Example)

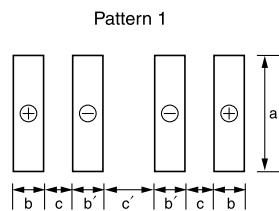

(mm)

Case	a	b	b'	c	c'
D	5.5	1.4	1.2	0.5	1.9
F	14	1.8	1.8	1.2	6.6

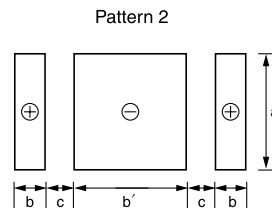

(mm)

Case	a	b	b'	c'
D	5.5	1.0	4.3	0.6
F	14	1.8	10.2	1.2

### ■ Frequency characteristic

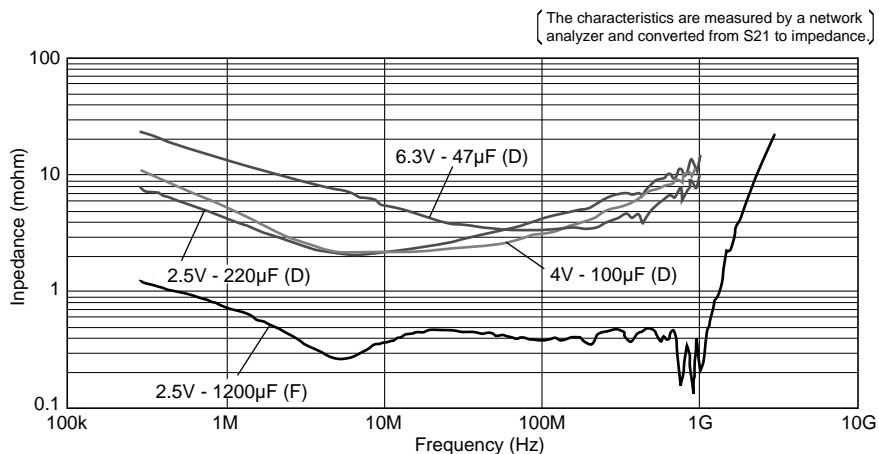

< Notice > The graph illustrates representative data. Please use this for reference only.